

*Rotate Chair 90° to fit through the door before attaching backrest

Distance needed from wall for full recline: **6"**

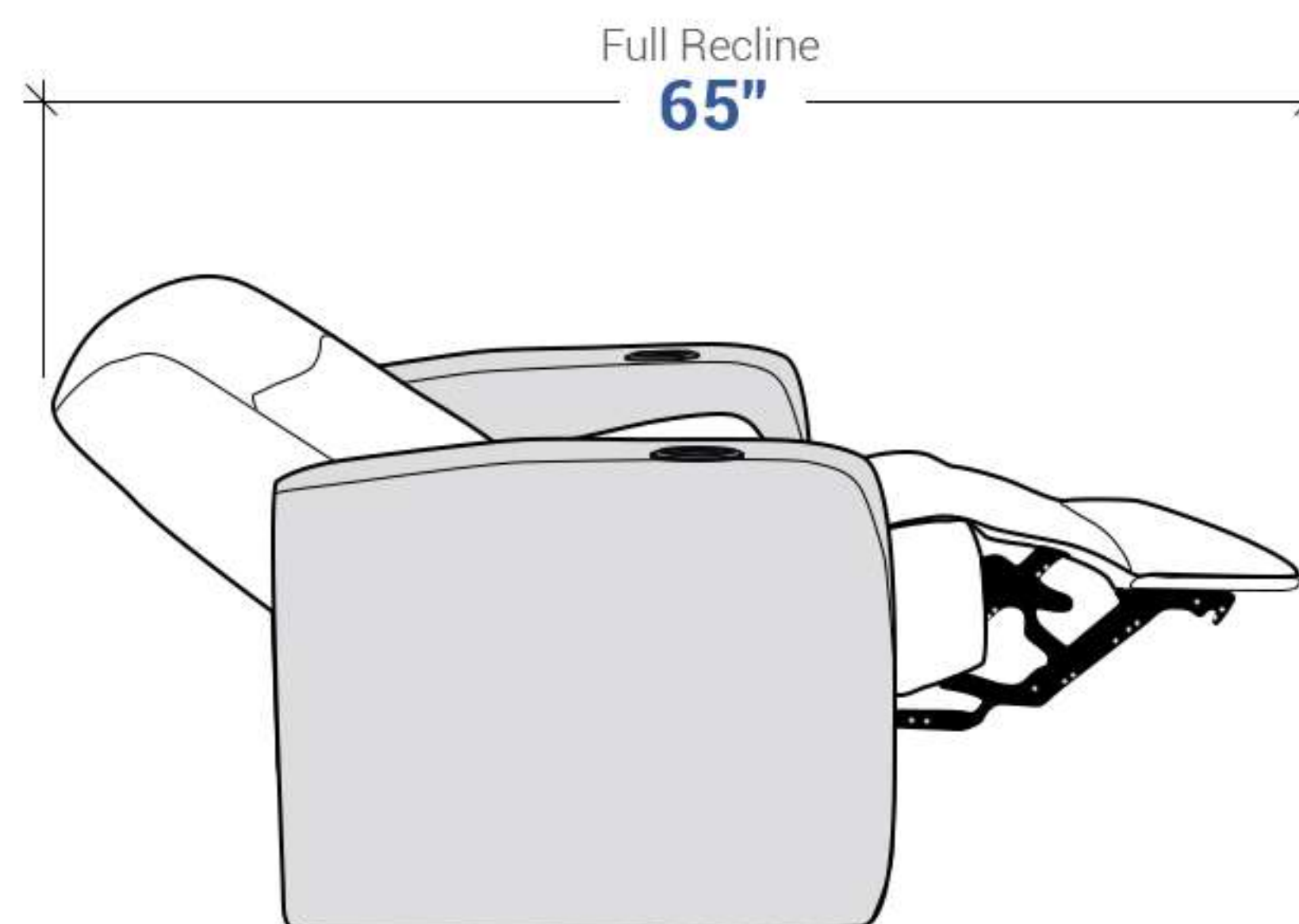
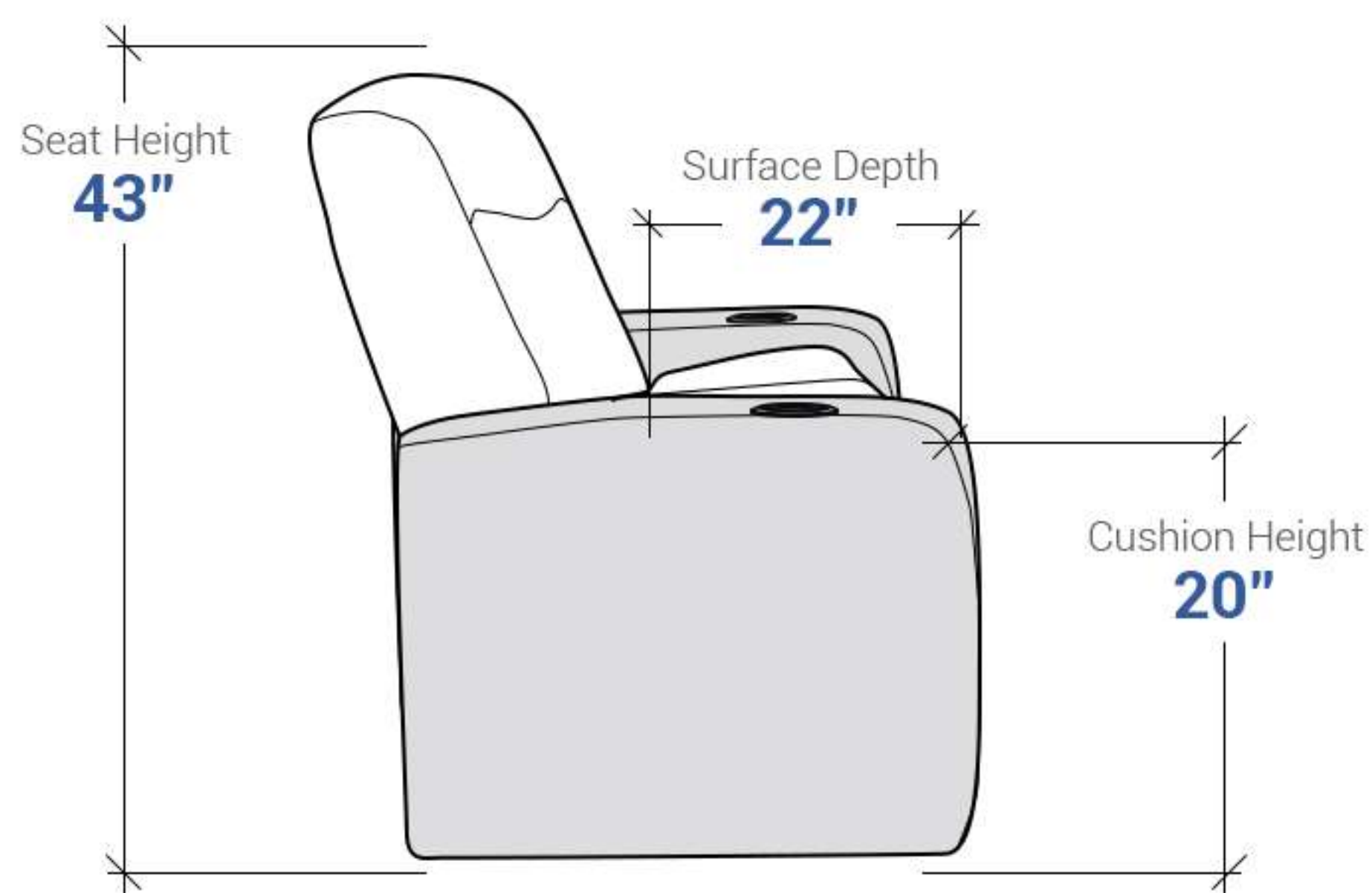
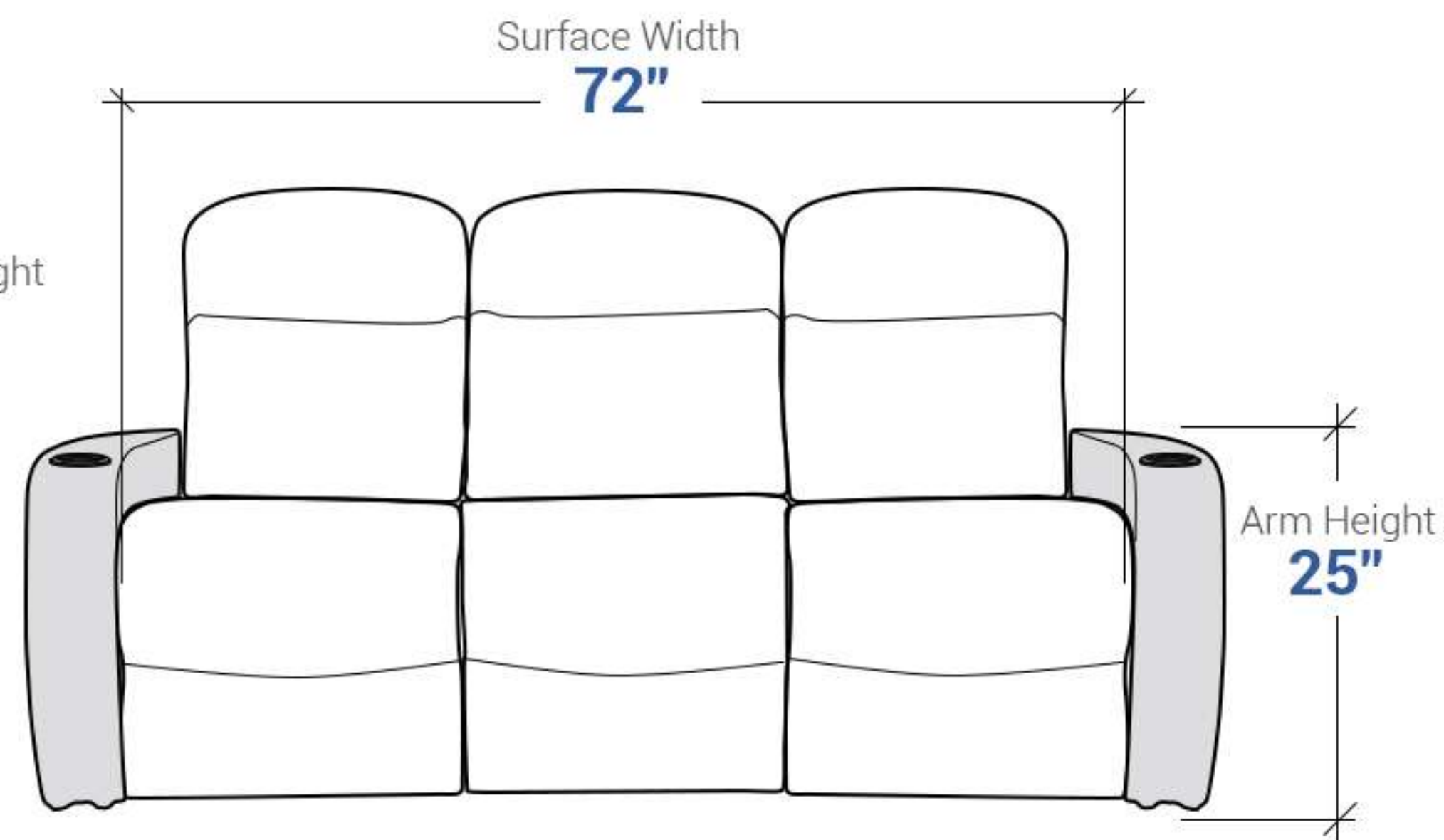
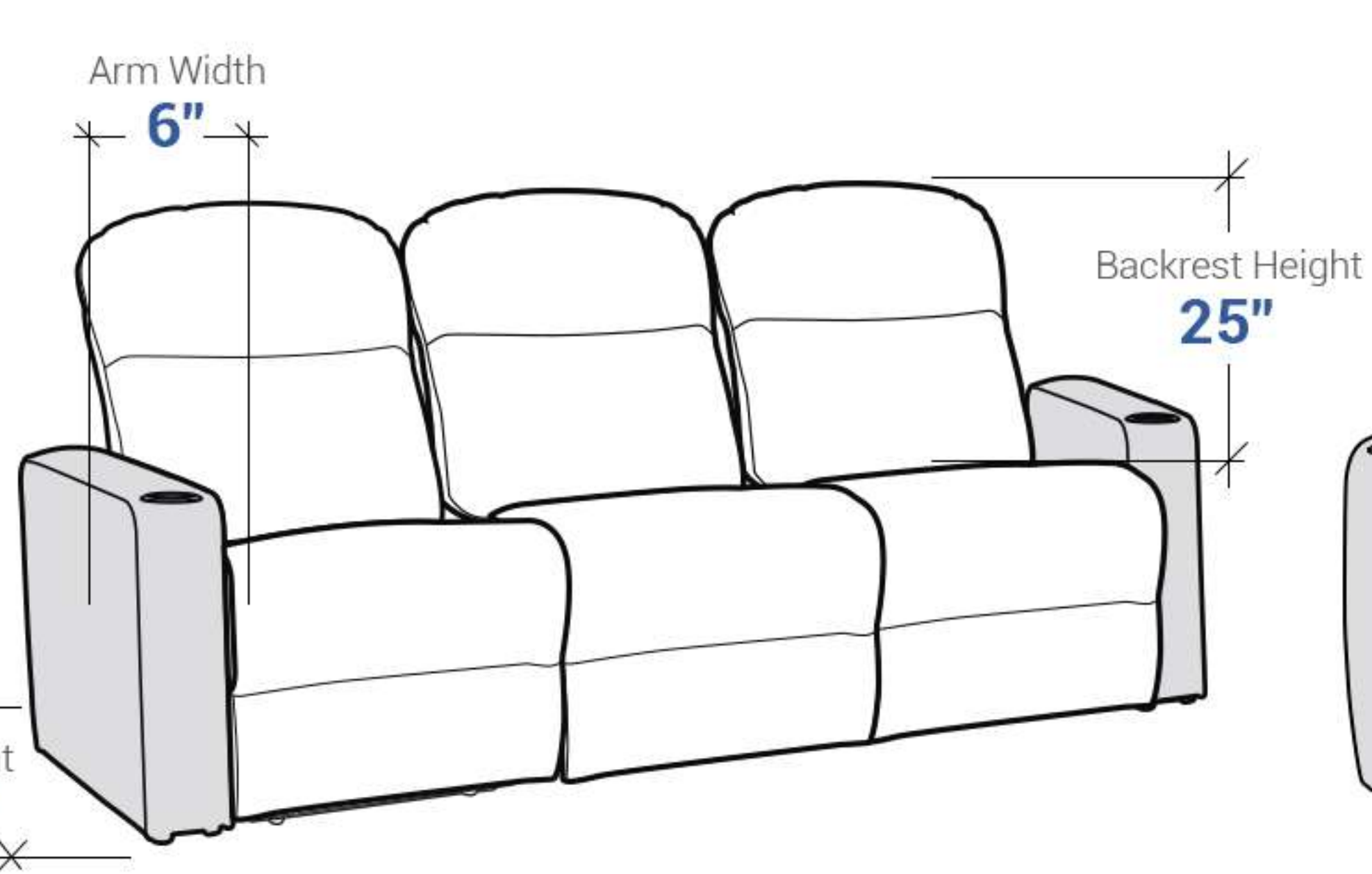

*Rotate Chair 90° to fit through the door before attaching backrest

Distance needed from wall for full recline: **6"**