

Distance needed from wall for full recline: **4"**

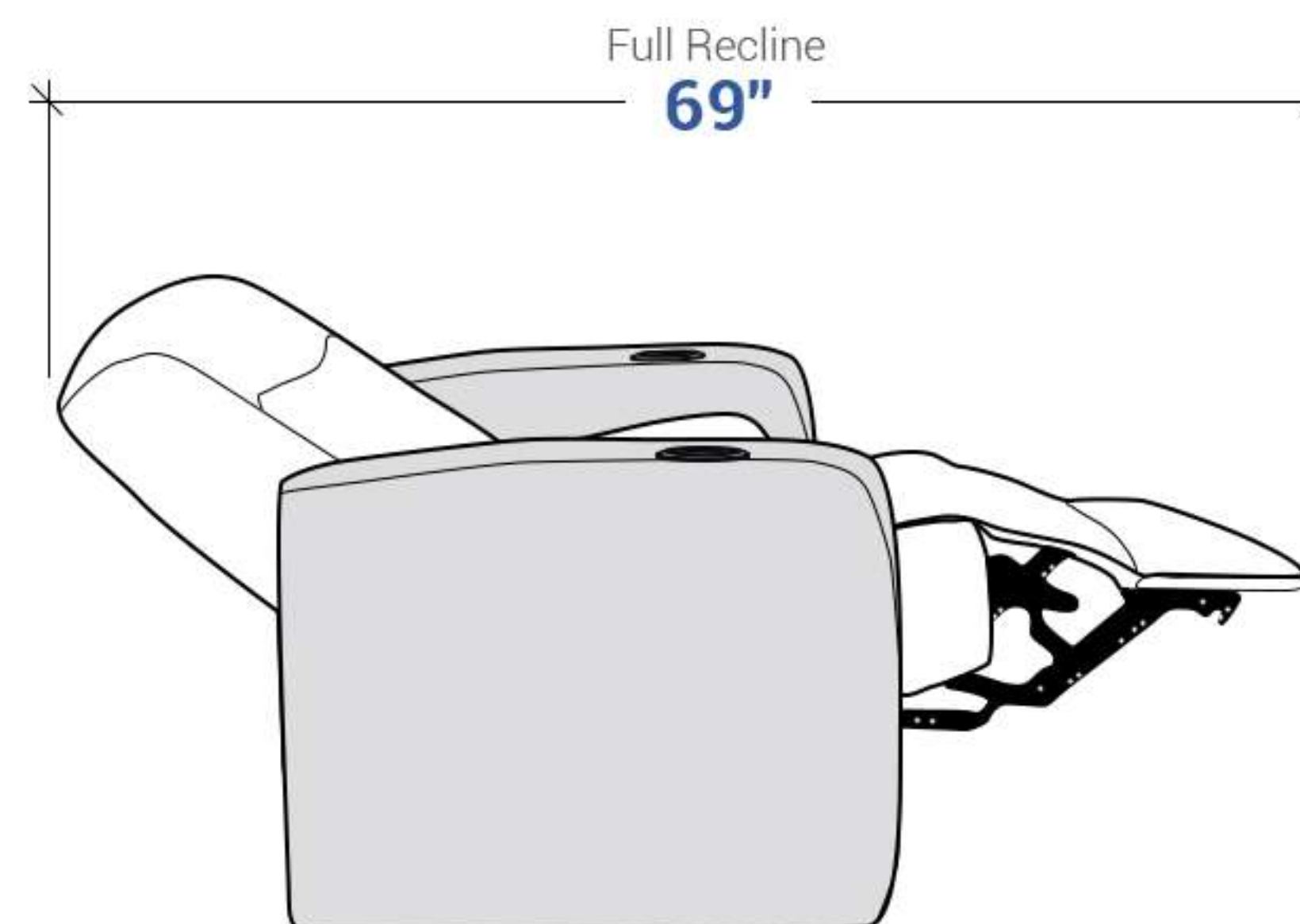

*Rotate Chair 90° to fit through the door before attaching backrest

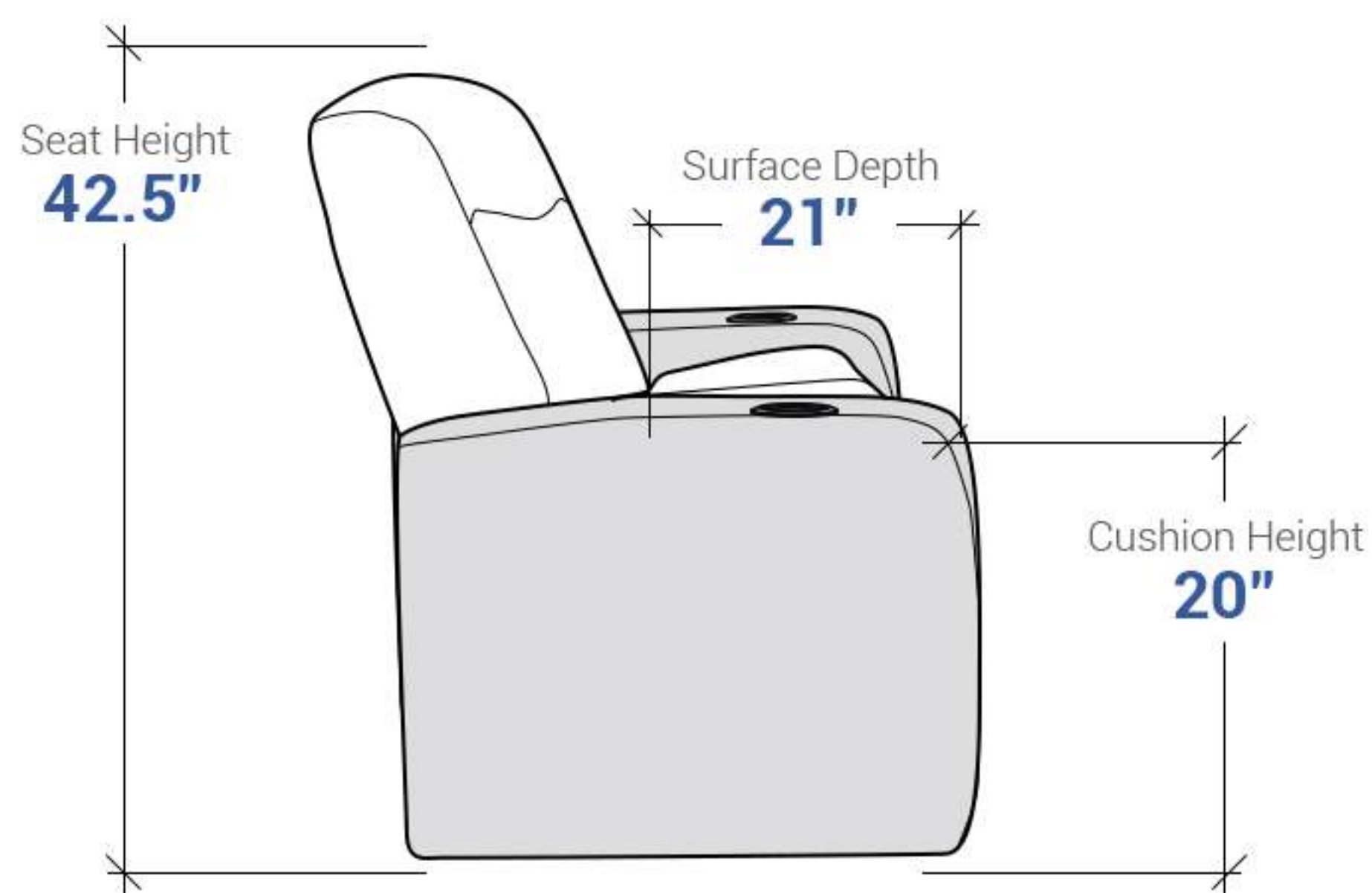
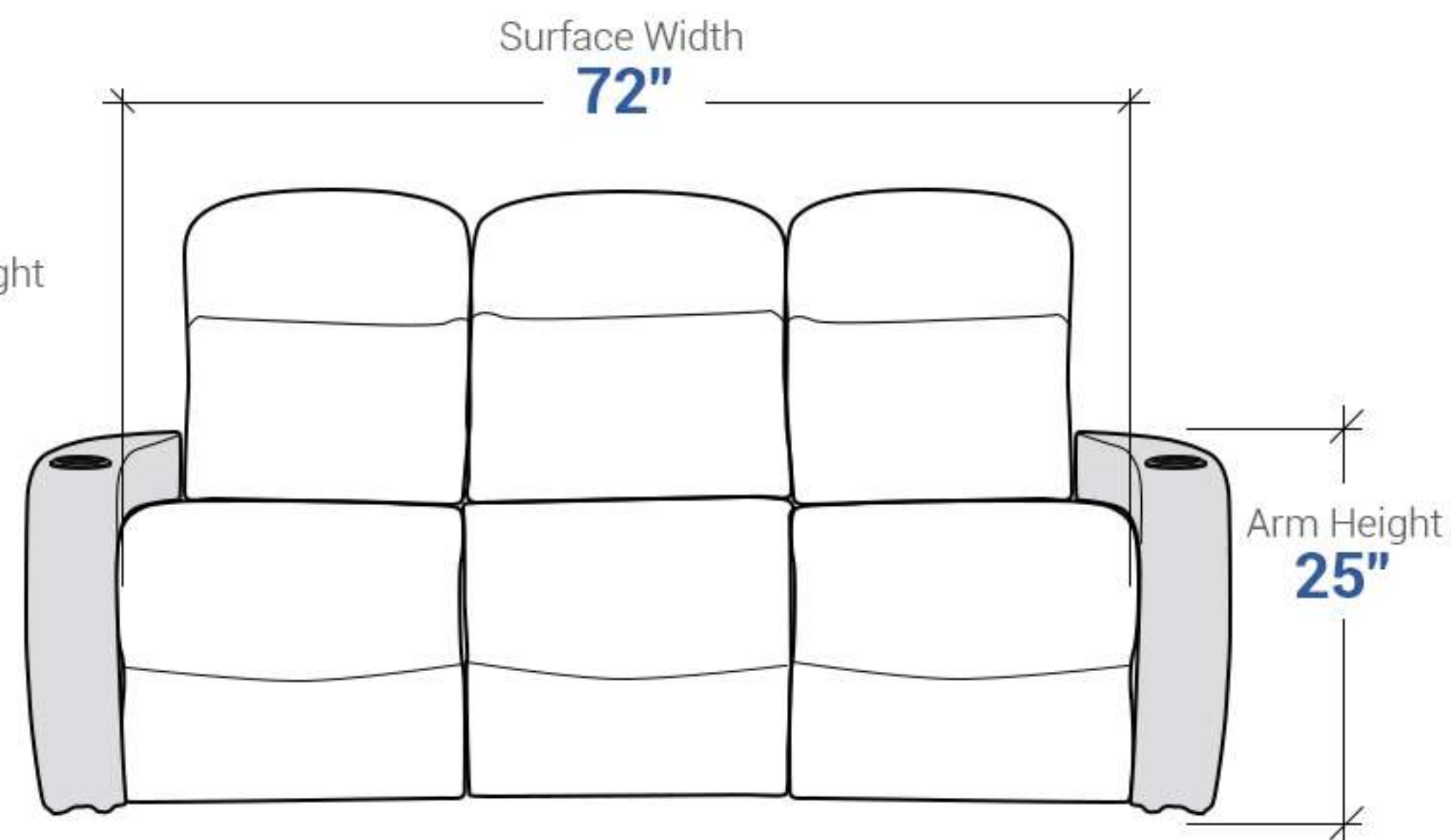
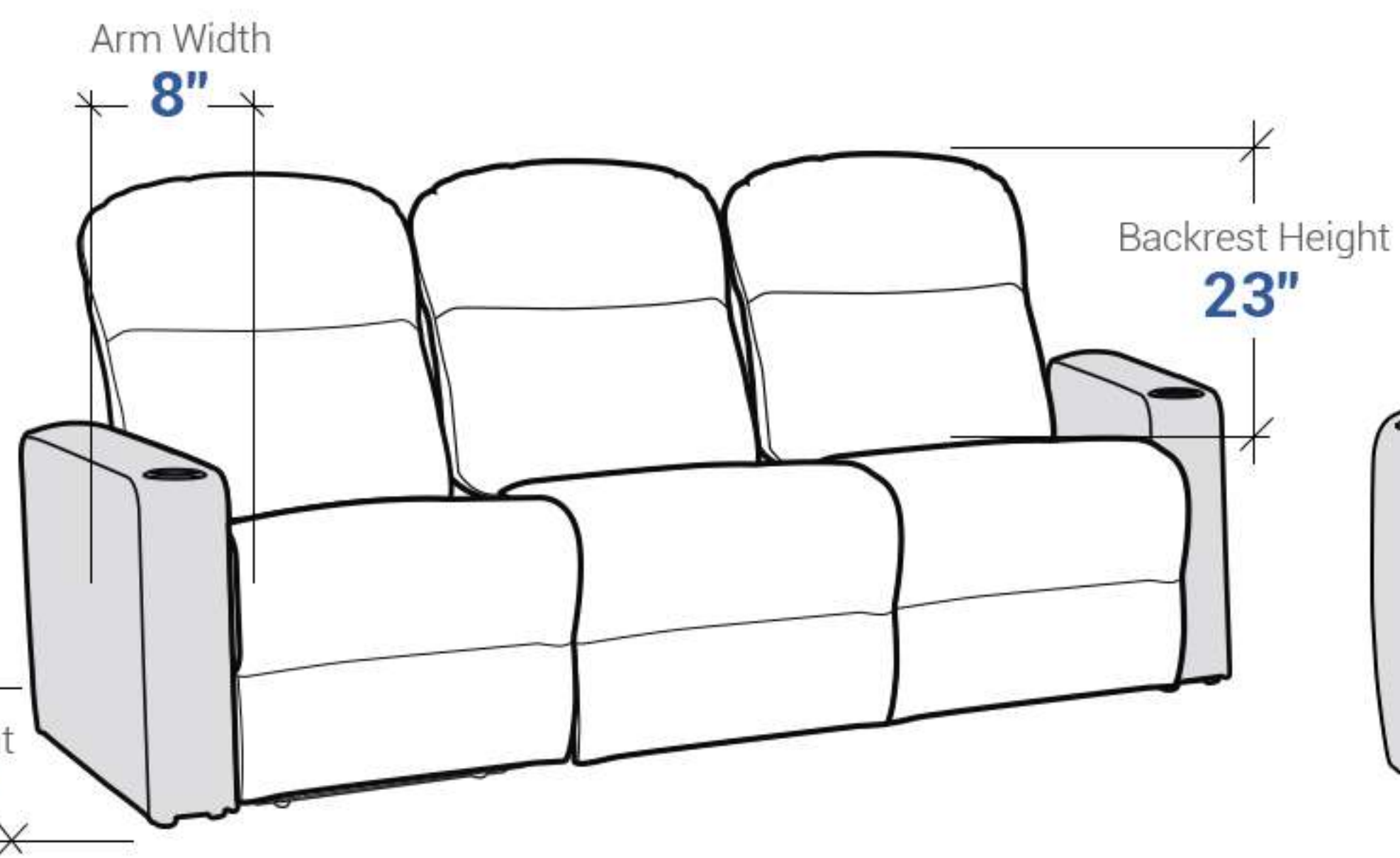

*Rotate Chair 90° to fit through the door before attaching backrest

Distance needed from wall for full recline: **4"**